

Solid State Relays

Industrial, 1-Phase ZS, High Volt./Current Range

Types RA 60 50 -D 16, RA .. 90 -D .., RA .. 110 -D..

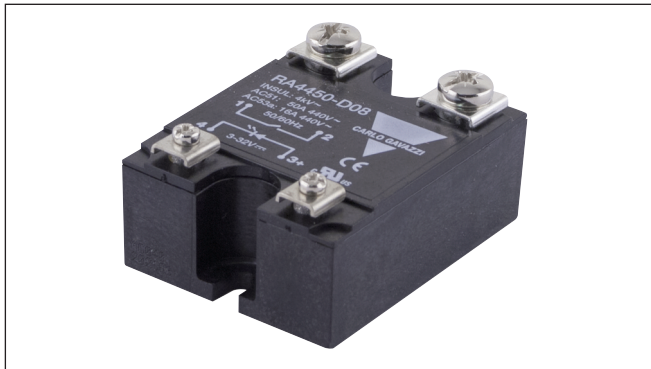

- High-current, high-voltage
- AC Solid State Relay
- Zero switching
- Rated operational current: 50, 90 and 110 AACrms
- Blocking voltage: U_p to 1600 V_p
- Rated operational voltage: Up to 600 VACrms
- High surge current capability
- Isolation: OPTO (input-output) 4000 VACrms



Product Description

These high-current, high-voltage solid state relays are designed for ON-OFF or phase controlling of high-power AC applications. High current and high dV/dt capabilities will allow switching of inductive loads e.g. transformers, motors, val-

ves and solenoids as well as all resistive loads. A zero crossing drive circuit will minimize the negative effects of different load types. Optocouplers provide an ideal interface to logic level DC-outputs.

Ordering Key

RA 60 110 -D 16

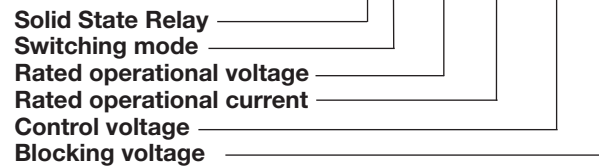

Type Selection

Switching mode	Rated operational voltage	Rated operational current	Control voltage	Blocking voltage
A: Zero switching	24: 230 VACrms	50: 50 AACrms	D: 4.5 to 32 VDC	06: 650 V _p
Optional:	40: 400 VACrms	90: 90 AACrms		10: 1000 V _p
B: Instant-on switching	48: 480 VACrms	110: 110 AACrms		12: 1200 V _p
	60: 600 VACrms			16: 1600 V _p

Selection Guide

Rated operational voltage	Blocking voltage	Control voltage	Rated operational current		
			50 AACrms	90 AACrms	110 AACrms
230 VACrms	650 V _p	4.5 to 32 VDC	*	*	RA 24110-D 06
400 VACrms	1000 V _p	4.5 to 32 VDC	*	RA 4090 -D 10	RA 40110-D 10
480 VACrms	1200 V _p	4.5 to 32 VDC	*	*	RA 48110-D 12
600 VACrms	1600 V _p	4.5 to 32 VDC	RA 6050 -D 16	RA 6090 -D 16	RA 60110-D 16

* Please refer to standard range, RA-relays.

General Specifications

	RA 24 .. -D 06	RA 40 .. -D 10	RA 48 .. -D 12	RA 60 .. -D 16
Operational voltage range	24 to 280 VACrms	24 to 440 VACrms	24 to 530 VACrms	24 to 690 VACrms
Blocking voltage	≥ 650 V _p	≥ 1000 V _p	≥ 1200 V _p	≥ 1600 V _p
Zero voltage turn-on	≤ 15 V	≤ 15 V	≤ 15 V	≤ 20 V
Operational frequency range	45 to 65 Hz	45 to 65 Hz	45 to 65 Hz	45 to 65 Hz
Power factor	≥ 0.5 @ 400 VACrms	≥ 0.5 @ 400 VACrms	≥ 0.5 @ 480 VACrms	≥ 0.5 @ 690 VACrms
Approvals	CSA, UR, EAC	CSA, UR, EAC	CSA, UR, EAC	CSA (max. 600 VAC), UR, EAC
CE-marking	Yes	Yes	Yes	Yes

Output Specifications

	RA 60 50 -D 16	RA .. 90 -D ..	RA .. 110 -D ..
Rated operational current AC 51 AC 53a	50 Arms 15 Arms	90 Arms 20 Arms	110 Arms 30 Arms
Minimum operational current	250 mArms	400 mArms	500 mArms
Rep. overload current t=1 s	≤ 125 Arms	≤ 150 Arms	≤ 200 Arms
Non-rep. surge current t=10 ms	600 A _p	1150 A _p	≤ 1900 A _p
Off-state leakage current @ rated voltage and frequency	≤ 2 mArms	≤ 2 mArms	≤ 5 mArms
I ² t for fusing t=10 ms	≤ 1800 A ² s	≤ 6600 A ² s	≤ 18000 A ² s
On-state voltage drop @ rated current	≤ 1.6 Vrms	≤ 1.6 Vrms	≤ 1.6 Vrms
Critical dV/dt commutating	≥ 500 V/μs	≥ 500 V/μs	≥ 500 V/μs
Critical dV/dt off-state	≥ 500 V/μs	≥ 500 V/μs	≥ 500 V/μs

Input Specifications

Control voltage range	4.5 to 32 VDC
Pick-up voltage	≥ 4.5 VDC
Drop-out voltage	≤ 1 VDC
Input current @ max. input voltage	≤ 40 mA
Reverse voltage	≤ 32 VDC
Response time pick-up	≤ 1/2 cycle
Response time drop-out	≤ 1/2 cycle

Housing Specifications

Weight	Approx. 110 g
Housing material	Noryl GFN 1, black
Base plate 50 A type 90 and 110 A types	Aluminium, nickel-plated Copper, nickel-plated
Potting compound	Polyurethane
Relay Mounting screws Mounting torque	M5 ≤ 1.5 Nm
Control terminal Mounting screws Mounting torque	M3 x 6 ≤ 0.5 Nm
Power terminal Mounting screws Mounting torque	M5 x 6 ≤ 2.4 Nm



Functional Diagram

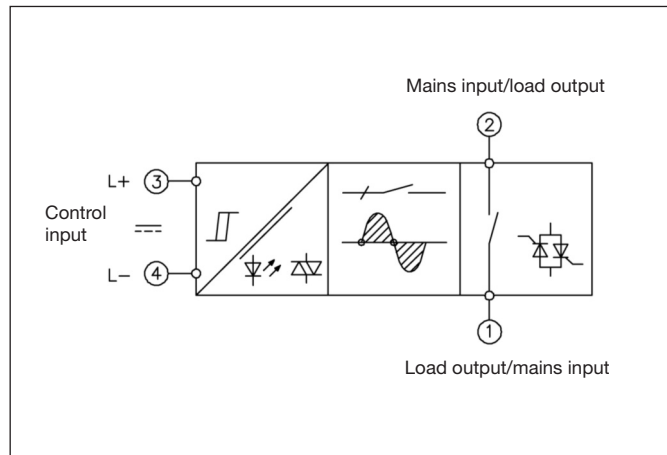

Dimensions

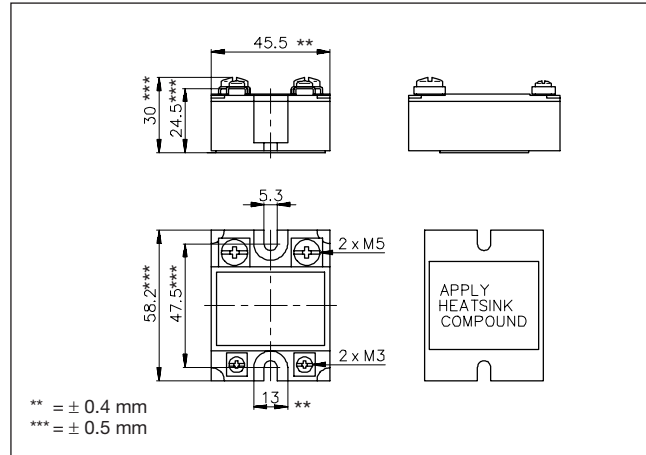

All dimensions in mm

Insulation

Rated isolation voltage Input to output	≥ 4000 VACrms
Rated isolation voltage Output to case	≥ 4000 VACrms
Insulation resistance Input to output	≥ 10 ¹⁰ Ω
Insulation resistance Output to case	≥ 10 ¹⁰ Ω
Insulation capacitance Input to output	≤ 16 pF
Insulation capacitance Output to case	≤ 100 pF

Wiring Diagram

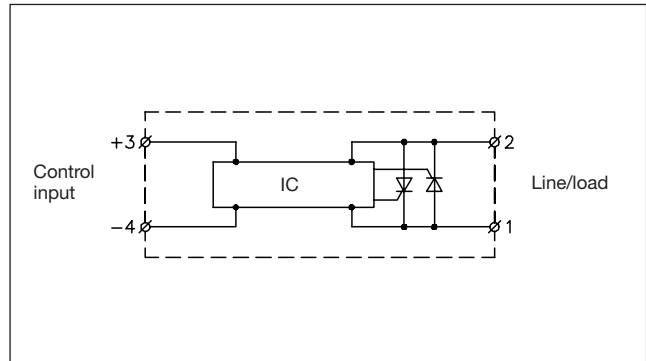



Heatsink Dimensions (load current versus ambient temperature)

RA 60 50 -D 16

Load current [A]	Thermal resistance [°C/W]						Power dissipation [W]
	20	30	40	50	60	70	
50	0.92	0.76	0.60	0.45	0.29	-	63
45	1.2	0.99	0.80	0.62	0.44	0.26	55
40	1.5	1.3	1.1	0.85	0.63	0.42	47
35	1.9	1.6	1.4	1.1	0.89	0.63	40
30	2.4	2.1	1.8	1.5	1.2	0.91	33
25	3	2.7	2.3	1.9	1.5	1.1	26
20	3.9	3.5	3	2.5	2	1.5	20
15	5.5	4.8	4.1	3.4	2.7	2.1	15
10	8.6	7.5	6.4	5.4	4.3	3.2	9
5	17.9	15.6	13.4	11.2	8.9	6.7	4

Ambient temp. [°C]

RA .. 90 .. -D ..

Load current [A]	Thermal resistance [°C/W]						Power dissipation [W]
	20	30	40	50	60	70	
90	0.63	0.53	0.42	0.32	-	-	97
80	0.81	0.69	0.57	0.45	0.33	-	84
70	1	0.89	0.75	0.61	0.47	0.33	71
60	1.3	1.2	1	0.83	0.66	0.49	59
50	1.7	1.5	1.3	1.1	0.85	0.64	47
40	2.2	1.9	1.7	1.4	1.1	0.83	36
30	3.1	2.7	2.3	1.9	1.5	1.2	26
20	4.8	4.2	3.6	3	2.4	1.8	17
10	10	8.8	7.5	6.3	5	3.8	8

Ambient temp. [°C]

RA.. 110-D ..

Load current [A]	Thermal resistance [°C/W]						Power dissipation [W]
	20	30	40	50	60	70	
110	0.43	0.35	0.27	-	-	-	126
90	0.63	0.53	0.42	0.32	-	-	97
80	0.81	0.69	0.57	0.45	0.33	-	84
70	1	0.89	0.75	0.61	0.47	0.33	71
60	1.3	1.2	1	0.83	0.66	0.49	59
50	1.7	1.5	1.3	1.1	0.85	0.64	47
40	2.2	1.9	1.7	1.4	1.1	0.83	36
30	3.1	2.7	2.3	1.9	1.5	1.2	26
20	4.8	4.2	3.6	3	2.4	1.8	17
10	10	8.8	7.5	6.3	5	3.8	8

Ambient temp. [°C]

Heatsink Selection

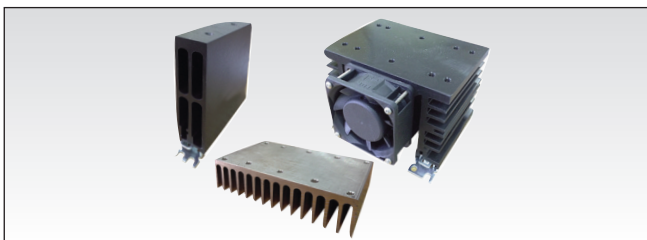

Heatsink Range Overview:
http://www.productselection.net/PDF/UK/ssr_accessories.pdf

Heatsink Selector Tool:
<http://www.productselection.net/heatsink/heatsinkselector.php?LANG=UK>

Ordering Key

RHS..

- Heatsinks and fans
- 0.25°C/W to 12.5°C/W thermal resistance
- DIN, panel or thru wall mounting
- Single or multiple SSR mounting

Applications

This relay is designed for use in applications in which it is exposed to high surge conditions. Care must be taken to ensure proper heatsinking when the relay is to be used at high sustained currents. Adequate electrical connection between relay terminals and cable must be ensured.

Thermal characteristics
The thermal design of Solid State Relays is very important.

It is essential that the user makes sure that cooling is adequate and that the maximum junction temperature of the relay is not exceeded.

If the heatsink is placed in a small closed room, control panel or the like, the power dissipation can cause the ambient temperature to rise. The heatsink is to be calculated on the basis of the ambient temperature and the increase in temperature.

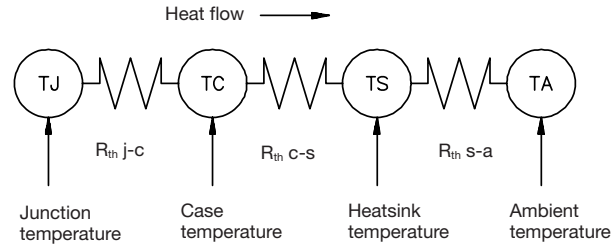

Thermal resistance:
 $R_{th\ j-c}$ = junction to case

$R_{th\ c-s}$ = case to heatsink
 $R_{th\ s-a}$ = heatsink to ambient

Motor start application (3-phase motors)
Starting time: 5 s max.
Running time/starting time ratio ≥ 10 .

Selection Guide

Motor size [kW]	Mains voltage	Relay type	Varistor voltage ¹	Heatsink ²	Full load current	Fuse type
11 kW	230/400 VAC	RA 40 90 -D 10	440 V	1°C/W	24 A	6.921 CP GRC 22x58/80
18.5 kW	230/400 VAC	RA 40 110 -D 10	440 V	0.5°C/W	39 A	6.921 CP GRC 22x58/100
22 kW	280/480 VAC	RA 48 110 -D 12	550 V	0.5°C/W	34 A	6.921 CP GRC 22x58/100
7.5 kW	400/600 VAC	RA 60 50 -D 16	680 V	3°C/W	11 A	6.921 CP GRC 22x58/50
18.5 kW	400/600 VAC	RA 60 90 -D 16	680 V	1°C/W	25 A	6.921 CP GRC 22x58/80
30 kW	400/600 VAC	RA 60 110 -D 16	680 V	0.5°C/W	39 A	6.921 CP GRC 22x58/100

¹: Varistor diameter min. 20 mm

²: Max. ambient temperature 50°C (one relay per heatsink)

3-phase switching circuit or 2-phase switching circuit

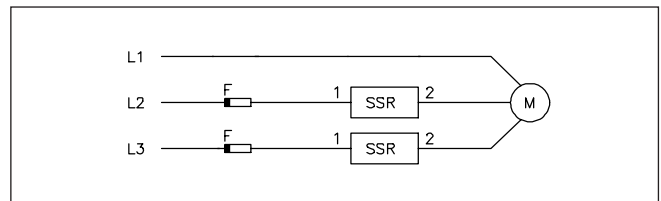
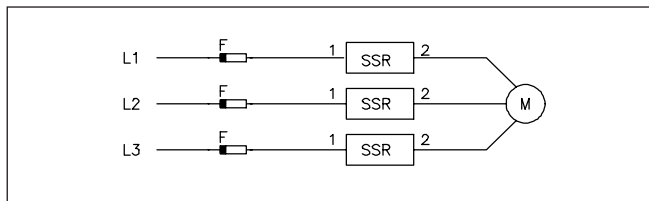

Thermal Specifications

	RA 60 50 -D 16	RA .. 90 -D ..	RA .. 110 -D ..
Operating temperature	-40° to +70°C (-40° to +158°F)	-20° to +70°C (-4° to +158°F)	-20° to +70°C (-4° to +158°F)
Storage temperature	-40° to +100°C (-40° to +212°F)	-40° to +100°C (-40° to +212°F)	-40° to +100°C (-40° to +212°F)
Junction temperature	$\leq 125^\circ\text{C}$ (257°F)	$\leq 125^\circ\text{C}$ (257°F)	$\leq 125^\circ\text{C}$ (257°F)
R_{th} junction to case	$\leq 0.65^\circ\text{C/W}$	$\leq 0.35^\circ\text{C/W}$	$\leq 0.3^\circ\text{C/W}$
R_{th} junction to ambient	$\leq 12^\circ\text{C/W}$	$\leq 12^\circ\text{C/W}$	$\leq 12^\circ\text{C/W}$

Environmental Specifications

Pollution degree	2 (non-conductive pollution with possibilities of condensation)
EU RoHS compliant	Yes
China RoHS compliant	Refer to Environmental Information (Page 6)



Environmental Information

The declaration in this section is prepared in compliance with People's Republic of China Electronic Industry Standard SJ/T11364-2014: Marking for the Restricted Use of Hazardous Substances in Electronic and Electrical Products.

Part Name	Toxic or Hazardous Substances and Elements					
	Lead (Pb)	Mercury (Hg)	Cadmium (Cd)	Hexavalent Chromium (Cr(VI))	Polybrominated biphenyls (PBB)	Polybrominated diphenyl ethers (PBDE)
Power Unit Assembly	x	○	○	○	○	○
○ Indicates that said hazardous substance contained in homogeneous materials for this part are below the limit requirement of GB/T 26572. X Indicates that said hazardous substance contained in one of the homogeneous materials used for this part is above the limit requirement of GB/T 26572.						

环境特性

这份申明根据中华人民共和国电子工业标准 SJ/T11364-2014：标注在电子电气产品中限定使用的有害物质

零件名称	有毒或有害物质与元素					
	铅 (Pb)	汞 (Hg)	镉 (Cd)	六价铬 (Cr(VI))	多溴化联苯 (PBB)	多溴联苯醚 (PBDE)
功率单元	x	○	○	○	○	○
○ 此零件所含材料中含有的该有害物质低于GB/T 26572的限值。 X 此零件某种材料中含有的该有害物质高于GB/T 26572的限值。						



Accessories

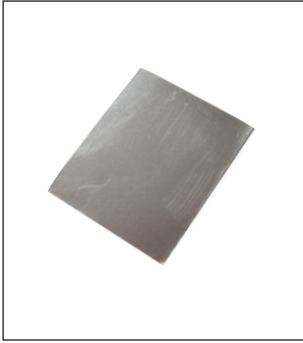

- Graphite thermal pad with adhesive on one side
- Type KK071CUT
- Dimensions: 35 x 43 x 0.25 mm
- Packing quantity: 50 pcs.

All accessories can be ordered pre-assembled with Solid State Relays.
Other accessories include DIN rail adaptors and varistors

For further information refer to Accessories datasheets at:
www.productselection.net/PDF/UK/SSR_Accessories.pdf