

DISxRSE

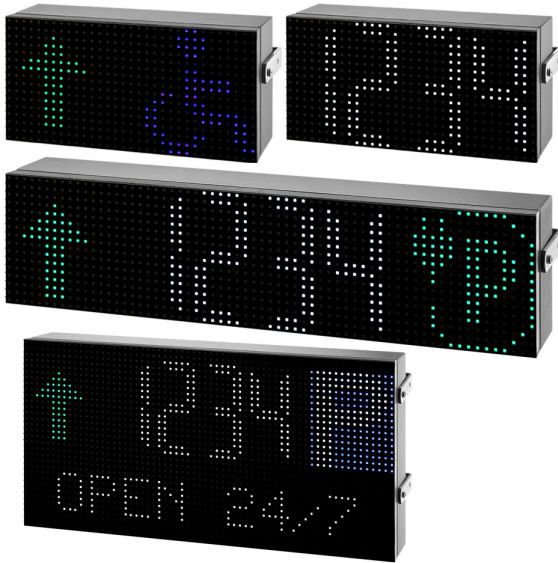

Carpark Display



Benefits

- Robust and aesthetic look display made of aluminium.
- Bright RGB LED matrix.
- The colour of the numeric digits can be selected between 7 available.
- Digits and symbols displayed in different combinations.
- Viewing distance up to 50 metres.
- Adjustable brightness with 4 light levels.
- Indoor and outdoor use.
- Temperature range down to -30 °C.
- Communication via bus or API.
- Programmable custom messages.
- Programmable digit dimensions.

Description

The DISxRSE displays are part of the Dupline® Carpark system, which contains other variants of sensors, controllers and displays.

It is used for guiding in car park facilities.

The displays can be programmed via the web-based configuration software: the available spaces can be displayed by means of different combinations of digits and symbols.

The displays are compatible with the Carpark systems based on the UWP 3.0/SBP2CPY24 controller and they must be connected to the display interface SBP2DI48524.

Applications

Display for parking guidance systems.

Main functions

- It shows arrows for direction, available spaces, symbols for category indication (disabled people, electric vehicles, etc..) in a parking area.

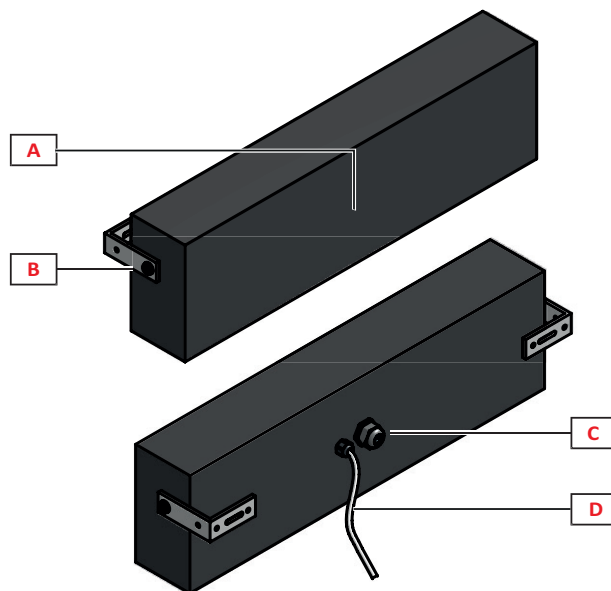
Structure

Area	Description
A	RGB LED matrix display
B	Mounting brackets for wall or ceiling mounting
C	Female Ethernet port
D	4-wire cable for power supply and communication protocol

Features

General

Material	Aluminium
Dimensions (HxWxD)	See fig. 1, 2, 3
Weight	DISARSE: 1800 g DISBRSE: 3200 g DISCRSE: 5500 g
Colour	Black
Protection grade	DISARSE, DISBRSE: IP55 DISCRSE: IP24

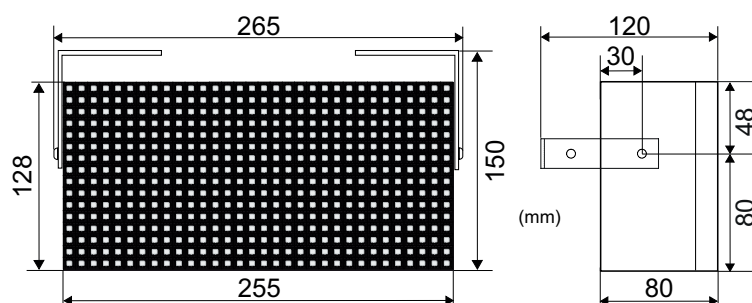

Fig. 1 DISARSE dimensions

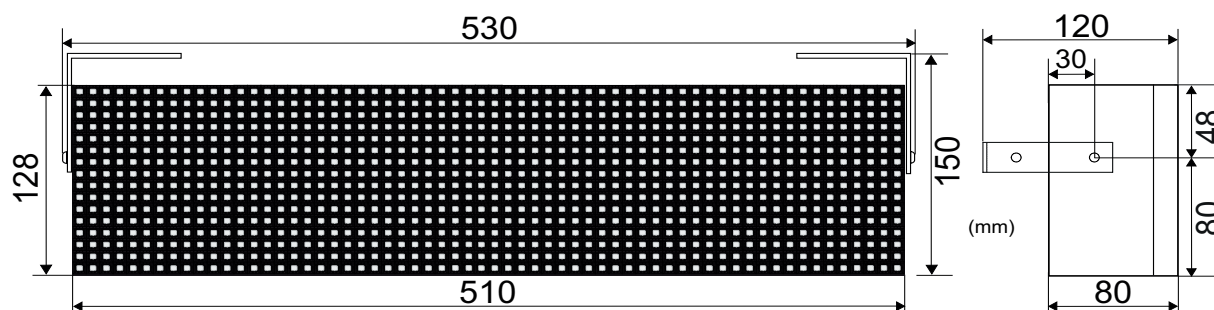

Fig. 2 DISBRSE dimensions

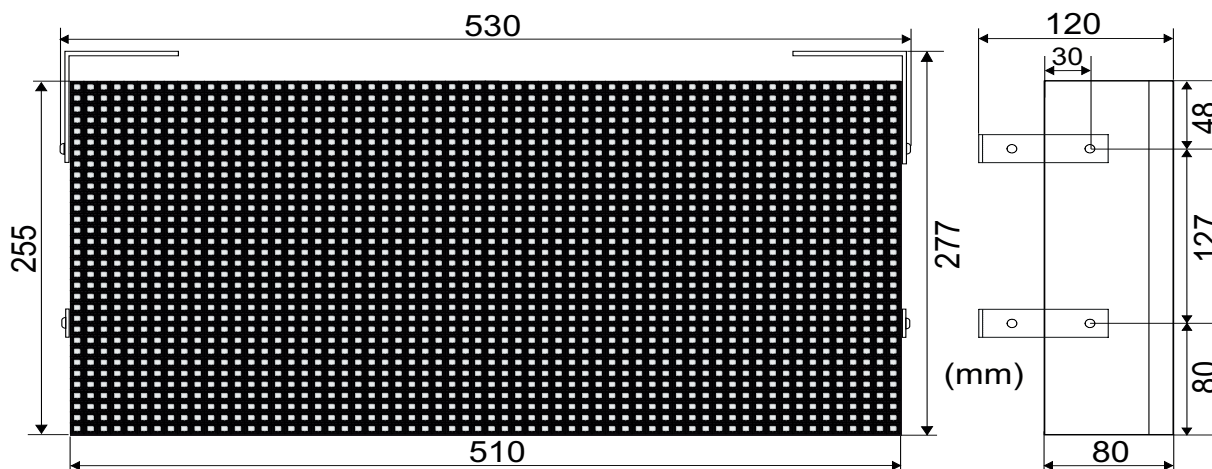

Fig. 3 DISCRSE dimensions

Environmental

Operating temperature	-30° to +55°C (-22° to +131°F)
Humidity (non-condensing)	10 to 90% RH

Compatibility and conformity

Approvals	CE
-----------	----

Power Supply

Power supply	24 VDC \pm 10%
Maximum rated operational power	DISARSE: 32 W DISBRSE: 53 W DISCRSE: 95 W

Display

Display resolution	DISARSE: 16 x 32 pixel DISBRSE: 16 x 64 pixel DISCRSE: 32 x 64 pixel
Technology	RGB LED SMD
LED lifetime	> 100 000 h
Display type	Dot matrix
Pixel pitch	8 mm
Viewing distance	> 50 m
Brightness control	4 light levels: adjustable via web-based configuration software

Ports

Ethernet

Interface	Ethernet
Protocol	HTTP, SOAP-API Note: the SOAP-API protocol does not require the SBP2DI48524 display interface.
Connection type	RJ45 connector (10 Base-T, 100 Base-TX); maximum distance: 100 m

RS485

Interface	RS485 2-wire
Protocol	Proprietary serial
Baud-rate	4800

Configuration

Connect the display to the SBP2DI48524 interface.

Power the SBP2DI48524 interface.

Configure the display via the integrated web-server by using an Ethernet connection.

There are two types of connections:

▶ **Ethernet direct connection**

Display and PC are directly connected with an Ethernet cable. A static IP address must be assigned to the PC.

Display and PC must have the same IP class and the same subnet mask address.

▶ **Via Router/switch**

Display and PC are connected to the same LAN via a router/switch device. Display and PC are configured with a dynamic/static IP address according to the network parameters.

To access the configuration page, enter the following parameters in a browser:

Parameters	Default value
Default IP address	192.168.1.201
<i>Note: this is the default IP address set in the factory and it will appear on the display at start-up.</i>	
Username	admin
Password	admin

The part number is automatically recognised by the software and all the relevant settings are shown.

Note: the display configuration is thoroughly described in the "Configuration manual".

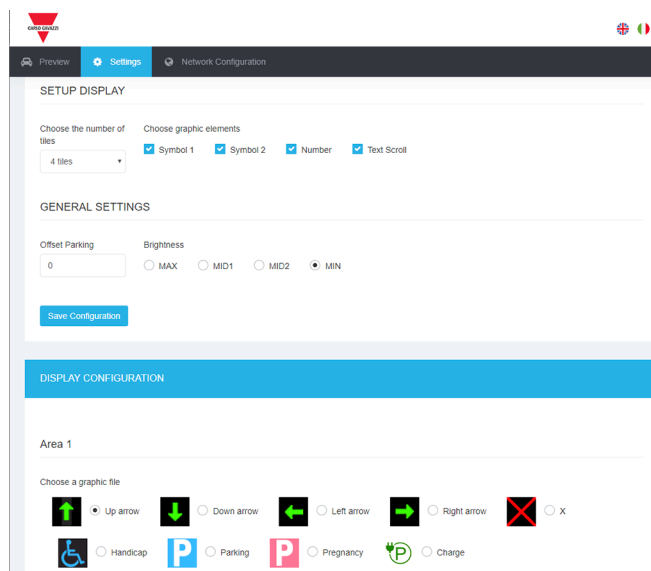

Areas

Area	Element	Note
1	Symbol 1	
2	Number	*For the DISARSE display, the maximum number of digits depends on the selected combination (see details below)
3	Symbol 2	
4	Scrolling text	This area is available only for the DISCRSE part number

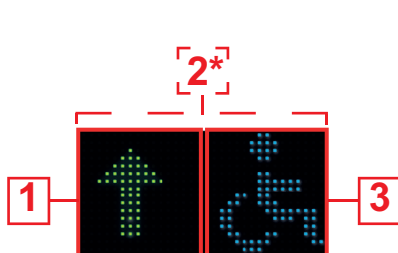

Fig. 4 DISARSE areas

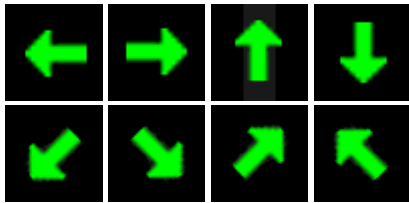







Fig. 5 DISBRSE and DISCRSE areas

Combinations

Part number	Available configurations	Note
DISARSE	Two symbols	One symbol on the left and one symbol on the right, no digits
	One symbol, up to two digits	One symbol on the left or one symbol on the right, up to two digits
	Four digits	No symbols, up to four digits
DISBRSE	Two symbols, up to four digits	One symbol on the left and one symbol on the right, up to four digits
	One symbol, up to four digits	One symbol on the left or one symbol on the right, up to four digits
	Four digits	No symbols, up to four digits
DISCRSE	Two symbols, up to four digits	One symbol on the left and one symbol on the right, up to four digits
	One symbol, up to four digits	One symbol on the left or one symbol on the right, up to four digits
	Four digits	No symbols, up to four digits
	Scrolling text	An alphanumeric text can be shown in addition to any other above mentioned combination
	Big digits	One symbol on the left or one symbol on the right, up to three big digits. No symbols, up to four big digits

Digits and symbols

Element	Symbols	Colour	Note
Digits	-	Tunable	Seven colours available
Scrolling text	-	Tunable	Seven colours available, up to 100 characters
Direction arrow		Green	The arrow can be set running or steady
Red cross		Red	The symbols can be displayed on both areas (area 1 and area 3). The arrow/cross can be selected in combination with another symbol.
Disabled people		Blue	
Electric vehicle		Light green	
P (Parking)		Blue and white	
Pregnant woman		Magenta	

Full parking event

The display can be programmed to inform when the monitored parking area is full. In the configuration page, there is a dedicated area where the user can set the combinations of text and symbols.

Example: The display can be set to show «FULL» and two red cross symbols.

Custom messages

Up to five custom messages can be set to show warnings or information instead of the available parking bays number. The custom message will be displayed according to the command that is sent by UWP 3.0.

Custom message	Default command value (range)	Notes
1	9001 ÷ 9010	<ul style="list-style-type: none"> The symbols cannot be shown Up to 7 colours available Scrolling text only on the DISBRSE / DISCRSE models The text message can be set steady or flashing
2	9011 ÷ 9020	
3	9021 ÷ 9030	
4	9031 ÷ 9040	
5	9041 ÷ 9050	

Connection Diagrams

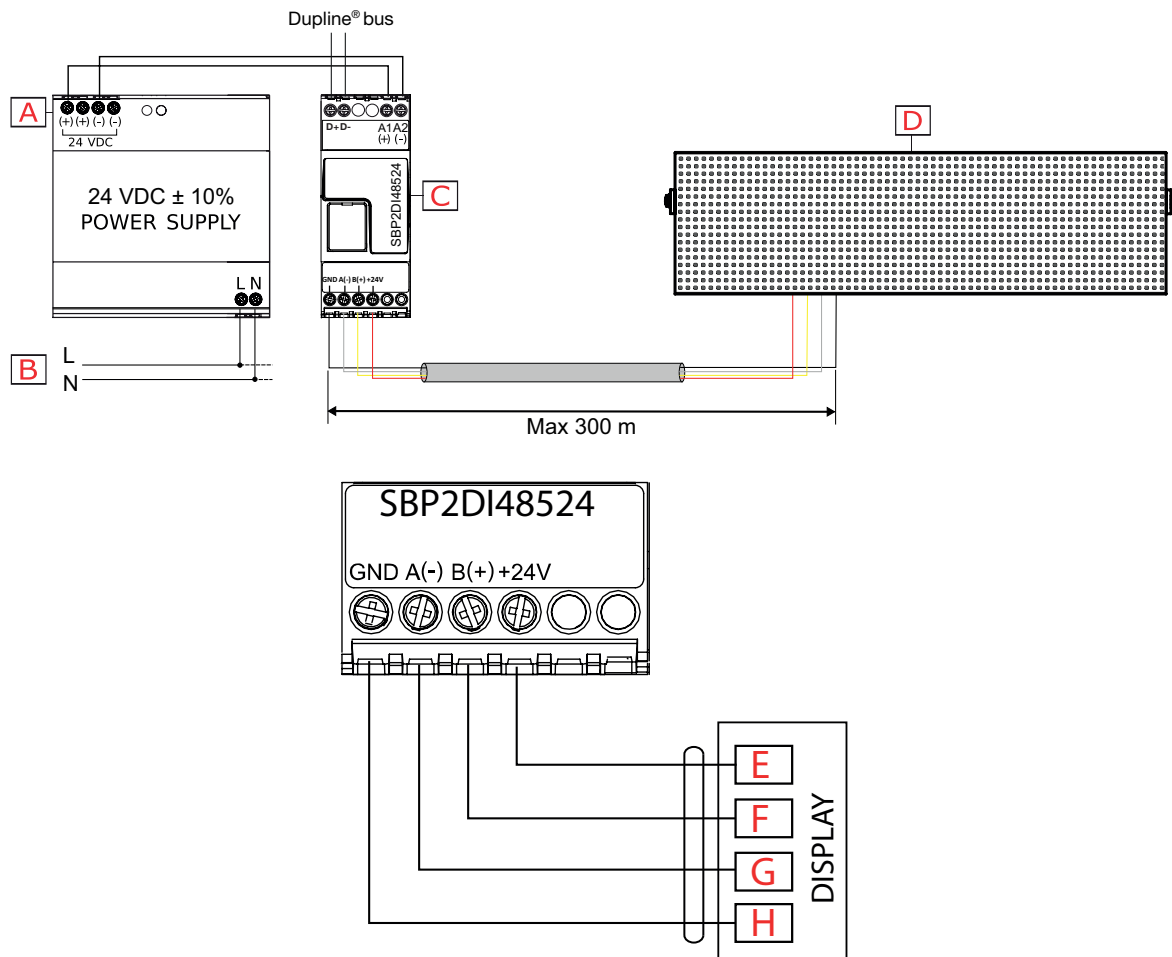

Fig. 6 Example of wiring

Element	Description	Element	Description
A	Power supply 24 VDC	E	+24 VDC
B	95 to 260 VAC	F	RS485 B(+)
C	Display interface SBP2DI48524	G	RS485 A(-)
D	DISxRSE display	H	GND

4-wire cable

Wire	Colour	Section	Cable length
+24 VDC	Red	0.5 mm ²	200 cm
GND	Black		
RS485 B(+)	Yellow	0.22 mm ²	
RS485 A(-)	White		

References

Further reading

Information	Document	Where to find it
Carpark installation	CP3 manual	www.productselection.net/MANUALS/UK/cp3_manual.pdf
UWP 3.0 installation guide	System manual	www.productselection.net/MANUALS/UK/system_manual.pdf
UWP 3.0 software manual	UWP 3.0 tool manual	www.productselection.net/MANUALS/UK/uwp3.0_tool.pdf
CP3 troubleshooting guide	Troubleshooting guide	www.productselection.net/MANUALS/UK/troubleshooting_guide.pdf
Installation manual	IM_DISARSE	www.productselection.net/MANUALS/UK/IM_DISARSE.pdf
	IM_DISBRSE	www.productselection.net/MANUALS/UK/IM_DISBRSE.pdf
	IM_DISCRSE	www.productselection.net/MANUALS/UK/IM_DISCRSE.pdf

Order code



DIS RSE

Complete the code entering the corresponding option instead of

Code	Option	Description
DIS	-	Display
<input type="checkbox"/>	A	Up to 4 digits or up to 2 symbols or 2 digits and 1 symbol
	B	Up to 4 digits and up to 2 symbols
	C	Up to 4 digits and up to 2 symbols, area for scrolling text
RS	-	RS485
E	-	Ethernet

CARLO GAVAZZI compatible components

Purpose	Component name/code	Notes
Controller	UWP30RSEXXX	
Bus generator	SBP2MCG324	
Display interface	SBP2DI48524	

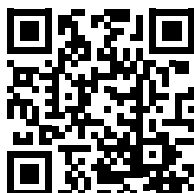

COPYRIGHT ©2021
Content subject to change. Download the PDF: www.productselection.net